



Benha University

Prof. Mohamed Ahmed Ebrahim

Benha University
Faculty of Engineering at Shoubra
Electrical Engineering Dept.



Industrial Controls (1)

By



Associate Prof. / Mohamed Ahmed Ebrahim Mohamed

E-mail: mohamedahmed_en@yahoo.com

mohamed.mohamed@feng.bu.edu.eg

Web site: <http://bu.edu.eg/staff/mohamedmohamed033>





Lecture (2)
11 – 04 – 2021



*Detecting sensors
&
actuating elements*

Introduction

- Sensors and actuators are two critical components of every closed loop control system. Such a system is also called a Mechatronics system.
- A typical control system as shown in figure consists of a sensing unit, a controller, and an actuating unit.

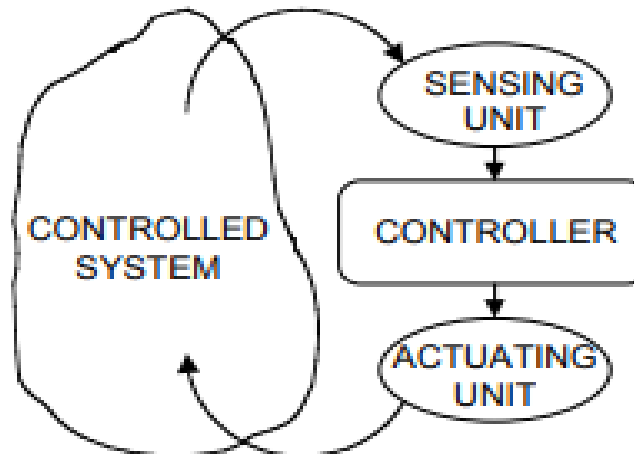

- A sensing unit can be as simple as a single sensor or can consist of additional components such as filters, amplifiers, modulators, and other signal conditioners.
- The controller accepts the information from the sensing unit, makes decisions based on the control algorithm, and outputs commands to the actuating unit.
- The actuating unit consists of an actuator and optionally a power supply and a coupling mechanism.

1. Detecting Sensors

- Sensor is a device that when exposed to a physical phenomenon (temperature, displacement, force, etc.) produces a proportional output signal (electrical, mechanical, magnetic, etc.).
- The term transducer is often used synonymously with sensors. However, ideally, a sensor is a device that responds to a change in the physical phenomenon.

1. Detecting Sensors

- On the other hand, a transducer is a device that converts one form of energy into another form of energy.
- Sensors are transducers when they sense one form of energy input and output in a different form of energy.
- **Ex:** a thermocouple responds to a temperature change (thermal energy) and outputs a proportional change in electromotive force (electrical energy). Therefore, a thermocouple can be called a sensor and or transducer.

1. Detecting Sensors

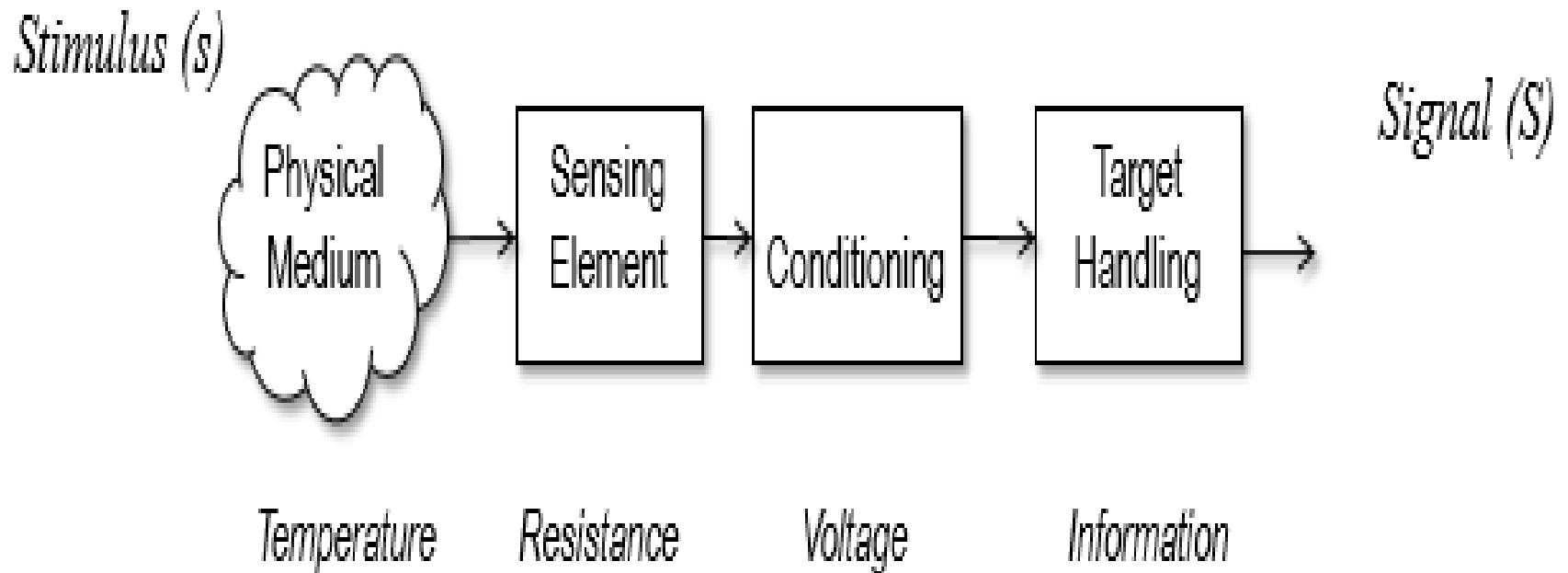

Basic Concepts of Sensors

- Sensors detect the presence of energy, changes in or the transfer of energy.
- Sensors detect by receiving a signal from a device such as a transducer, then responding to that signal by converting it into an output that can easily be read and understood.
- Typically sensors convert a recognized signal into an electrical analog or digital output that is readable.
- **EX:** The light bulb converts electrical energy into light and heat; however, it does not quantify how much light or heat. If the purpose of a device is to quantify an energy level, it is a sensor.

So let's take a look at a sensor that should be familiar to everyone(a temperature sensor)

- A thermometer senses and converts temperature into a readable output, thus it is a sensor. This output can be direct or indirect.
- A digital readout thermometer is an indirect output. For a digital readout thermometer, a converter is used to convert the output of the temperature transducer to an input for the digital display.
- The measured temperature is displayed on a monitor. The thermometer is both a transducer and a sensor (quantifies the transducer output with a readable format).



Prof. Mohamed Ahmed Ebrahim

Types of sensors which are classified by the type of energy they detect

- A. Thermal Sensors.
- B. Mechanical Sensors.
- C. Electrical Sensors.
- D. Chemical Sensors.
- E. Other sensors.

A. Thermal Sensors

1. Thermometer:

- measures absolute temperature.

2. Thermocouple gauge:

- measures temperature by its affect on two dissimilar metals.

3. Calorimeter

- measures the heat of chemical reactions or physical changes and heat capacity

A. Theory of Operation

- A thermocouple is a device that directly converts thermal energy into electrical energy.
- When two dissimilar metal wires are connected at one end forming a junction, and that junction is heated, a voltage is generated across the junction.
- If the opposite ends of the wires are connected to a meter, the amount of generated voltage can be measured.
- The voltage created in this situation is proportional to the temperature of the junction.

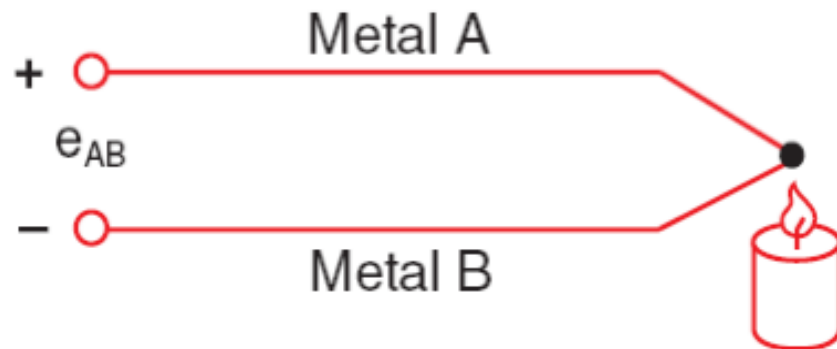

B. Mechanical Sensors

1. **Pressure sensor:** measures pressure.
2. **Barometer:** measures atmospheric pressure.
3. **Altimeter:** measures the altitude of an object above a fixed level.
4. **Liquid flow sensor:** measures liquid flow rate.
5. **Gas flow sensor:** measures velocity, direction, and/or flow rate of a gas.
6. **Accelerometer:** measures acceleration

Theory of Operation

- Mercury Barometers determine the level of atmospheric pressure.
- A tube is initially filled with mercury and then inverted into a dish.
- Some of the mercury from the tube flows into the dish (reservoir) creating a vacuum in the upper portion of the tube.
- The flow stops when equilibrium is reached between the pressures on the surfaces inside the tube and in the reservoir.
- When the atmospheric pressure increases, the level of the mercury in the tube rises. This is due to an increase in pressure on the mercury's surface in the reservoir.
- A decrease in the level of mercury in the tube is seen when the atmospheric pressure drops.

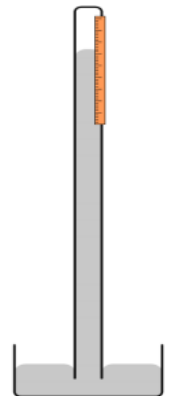

Schematic of a mercury barometer

C. Electrical Sensors

1. **Ohmmeter:** measures resistance.
2. **Voltmeter:** measures voltage.
3. **Galvanometer:** measures current.
4. **Watt-hour meter:** measures the amount of electrical energy supplied to and used by a residence or business.

Theory of operation

- A Galvanometer is a specific type of ammeter used for sensing an electrical current.
- Current flows through a coil (the red wire wound around a metal cylinder) creating a magnetic field. Permanent magnets surround the coil.
- The interaction of these two magnetic fields causes the coil/cylinder combination to pivot around its central axis.
- The amount and direction of the pivot moves the needle on a readout (right image) left or right, indicating the level of current and its polarity (negative or positive, respectively).
- This device uses two energy conversions to sense and quantify an electric current: electrical to magnetic and magnetic to mechanical rotation.

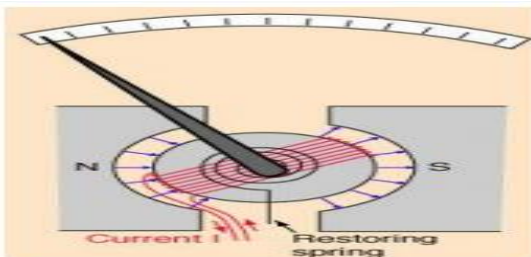

Schematic and photograph of a Galvanometer used for sensing electrical currents

D. Chemical Sensors

- Chemical sensors detect the presence of certain chemicals or classes of chemicals and quantify the amount and/or type of chemical detected.
 1. **Oxygen sensor:** measures the percentage of oxygen in a gas or liquid being analyzed.
 2. **Carbon dioxide detector:** detects the presence of CO₂

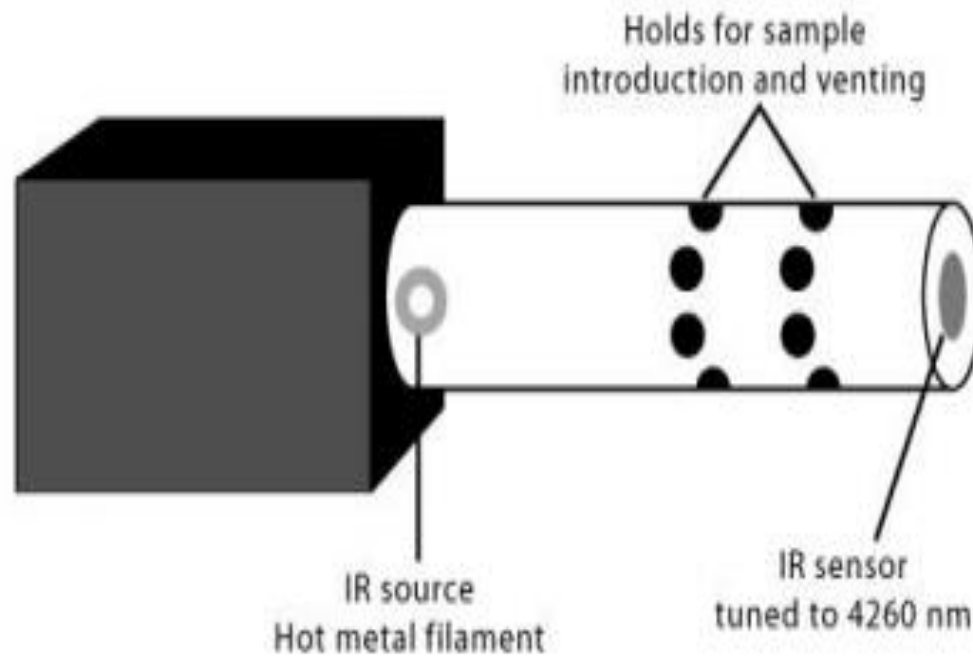

(Schematic and Photo of a Carbon Dioxide Sensor)

D. Other types of Sensors

1. **Optical**

- **Light sensors (photodetectors):** detects light and electromagnetic energy.
- **Photocells (photoresistor):** a variable resistor affected by intensity changes in ambient light.
- **Infra-red sensor:** detects infra-red radiation.

2. **Other**

- **Motion:** detects motion.
- **Speedometer:** measures speed.
- **Biological:** monitors human cells

Selecting Criteria for Sensors

- A number of static and dynamic factors must be considered in selecting a suitable sensor to measure the desired physical parameter.
- **Following is a list of typical factors:**
 - a) **Range:** Difference between the maximum and minimum value of the sensed parameter.
 - b) **Resolution:** The smallest change the sensor can differentiate.
 - c) **Accuracy:** Difference between the measured value and the true value.

Selecting Criteria for Sensors

- d) **Precision:** Ability to reproduce repeatedly with a given accuracy.
- e) **Sensitivity:** Ratio of change in output to a unit change of the input.
- f) **Zero offset:** A nonzero value output for no input.
- g) **Linearity:** Percentage of deviation from the best-fit linear calibration curve.
- h) **Zero Drift:** The departure of output from zero value over a period of time for no input.
- i) **Response time:** The time lag between the input and output.
- j) **Bandwidth:** Frequency at which the output magnitude drops by 3 dB.

Selecting Criteria for Sensors

- k) **Resonance:** The frequency at which the output magnitude peak occurs.
- l) **Operating temperature:** The range in which the sensor performs as specified.
- m) **Dead band:** The range of input for which there is no output.
- n) **Signal-to-noise ratio:** Ratio between the magnitudes of the signal and the noise at the output

2. Actuating Elements

- Actuators are basically the muscle behind a mechatronics system that accepts a control command (mostly in the form of an electrical signal) and produces a change in the physical system by generating force, motion, heat, flow, etc.
- Normally, the actuators are used in conjunction with the power supply and a coupling mechanism.

- The power unit provides either AC or DC power at the rated voltage and current.
- The coupling mechanism acts as the interface between the actuator and the physical system. Typical mechanisms include rack and pinion, gear drive, belt drive, lead screw and nut, piston, and linkages.

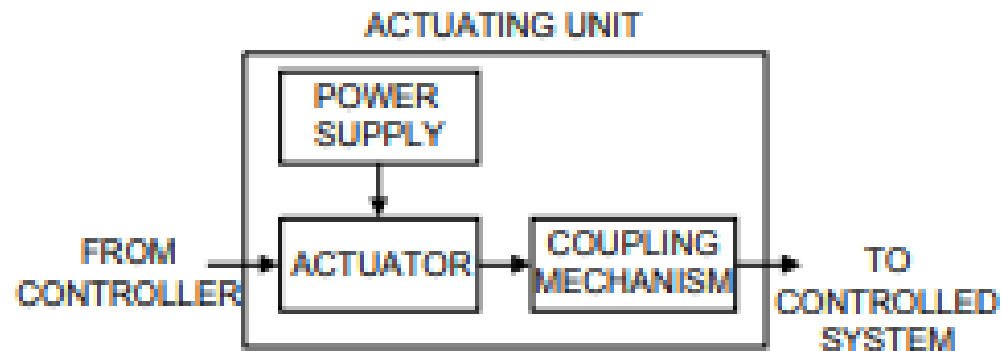

Basic Concepts of Actuators

- An actuator is something that actuates or moves something.
- More specifically, an actuator is a device that converts energy into motion or mechanical energy.
- Therefore, an actuator is a specific type of a **transducer**.

Actuators can be classified based on the type of energy:

- a) **Electrical Actuators.**
- b) **Electromagnetic Actuators.**
- c) **Electromagnetic Actuators.**
- d) **Hydraulic and Pneumatic Actuators.**

a) Electrical Actuators

- Electrical switches are the choice of actuators for most of the on-off type control action.
- Switching devices such as diodes, transistors, triacs, MOSFET, and relays accept a low energy level command signal from the controller and switch on or off electrical devices such as motors, valves, and heating elements.

- **Ex:** a MOSFET switch is shown in figure, The gate terminal receives the low energy control signal from the controller that makes or breaks the connection between the power supply and the actuator load.
- When switches are used, the designer must make sure that switch bounce problem is eliminated either by hardware or software.

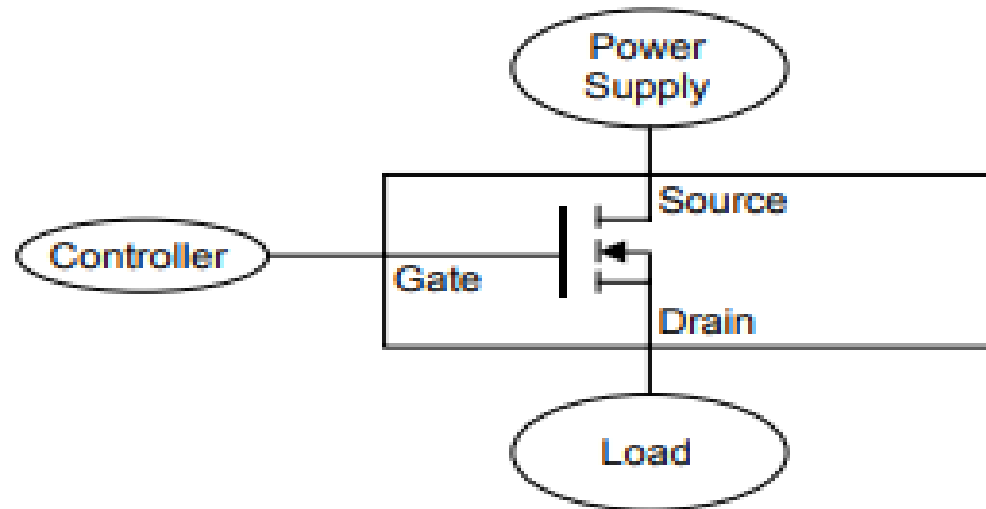

b) Electromagnetic Actuators

- **The solenoid** is the most common electromagnetic actuator. A DC solenoid actuator consists of a soft iron core enclosed within a current carrying coil.
- When the coil is energized, a magnetic field is established that provides the force to push or pull the iron core.
- AC solenoid devices are also encountered, such as AC excitation relay.

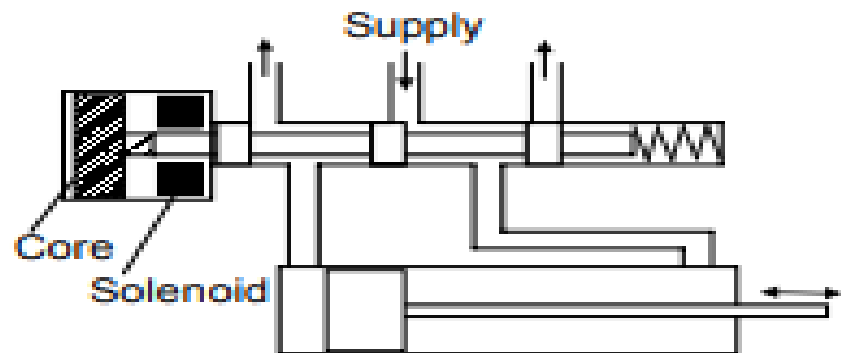

c) Hydraulic and Pneumatic Actuators

- Hydraulic and pneumatic actuators are normally either rotary motors or linear piston/cylinder or control valves.
- They are ideally suited for generating very large forces coupled with large motion.
- **Pneumatic actuators** use air under pressure that is most suitable for low to medium force, short stroke, and highspeed applications.
- **Hydraulic actuators** use pressurized oil that is incompressible.

- They can produce very large forces coupled with large motion in a cost-effective manner. The disadvantage with the hydraulic actuators is that they are more complex and need more maintenance.

Selecting Criteria for Actuators

- **the following performance parameters** must be addressed before choosing an actuator for a specific need:
 - a) **Continuous power output:** The maximum force/torque attainable continuously without exceeding the temperature limits.
 - b) **Range of motion:** The range of linear/rotary motion.
 - c) **Resolution:** The minimum increment of force/torque attainable.

- d) **Accuracy:** Linearity of the relationship between the input and output.
- e) **Peak force/torque:** The force/torque at which the actuator stalls.
- f) **Heat dissipation:** Maximum wattage of heat dissipation in continuous operation.
- g) **Speed characteristics:** Force/torque versus speed relationship.
- h) **No load speed:** Typical operating speed/velocity with no external load.
- i) **Frequency response:** The range of frequency over which the output follows the input faithfully, applicable to linear actuators.
- j) **Power requirement:** Type of power (AC or DC), number of phases, voltage level, and current capacity

Thank You
For Your Attention



*Mohamed Ahmed
Ebrahim*